

# 2016 BUSH BEAN BED

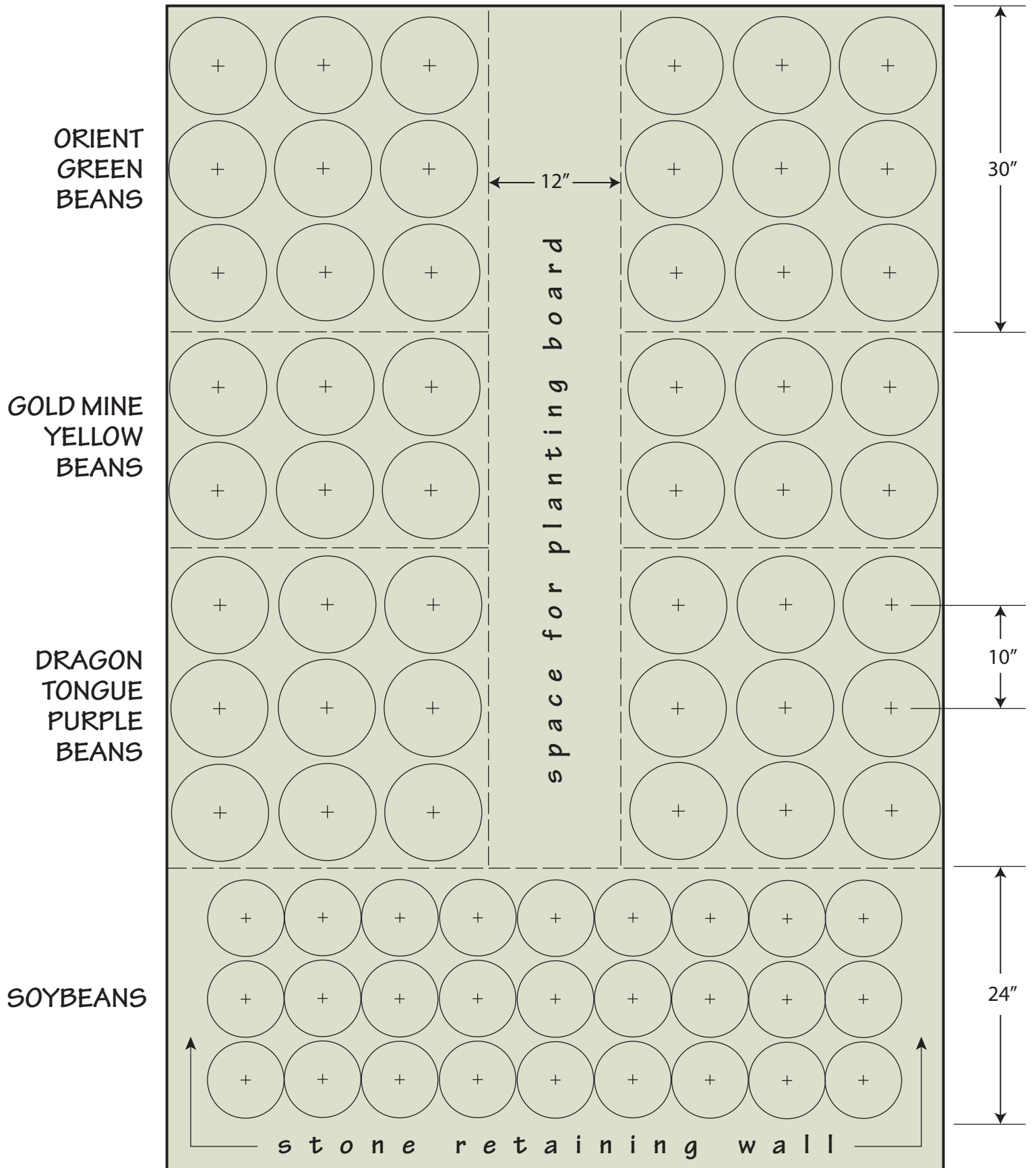

# 2016 BROCCOLI & BRUSSELS SPROUTS BED

**BRUSSELS  
SPROUTS**  
(5 plants  
each of  
Octia &  
Churchill)

**SPRING  
BROCCOLI  
& FALL  
BRASSICAS**  
(23 plants)

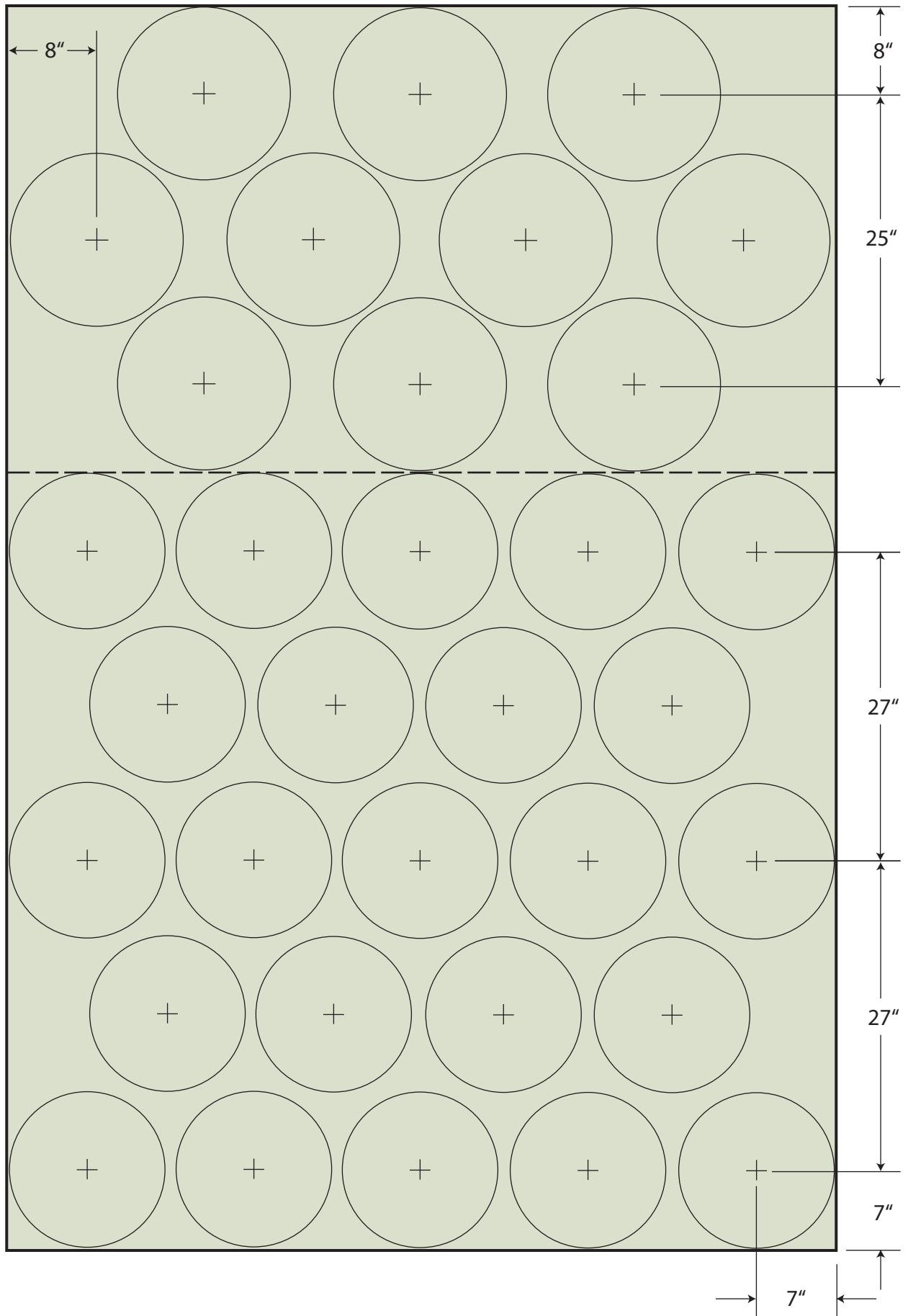

# 2016 CABBAGE, POTATO & FALL BRASSICAS BED (Spring)

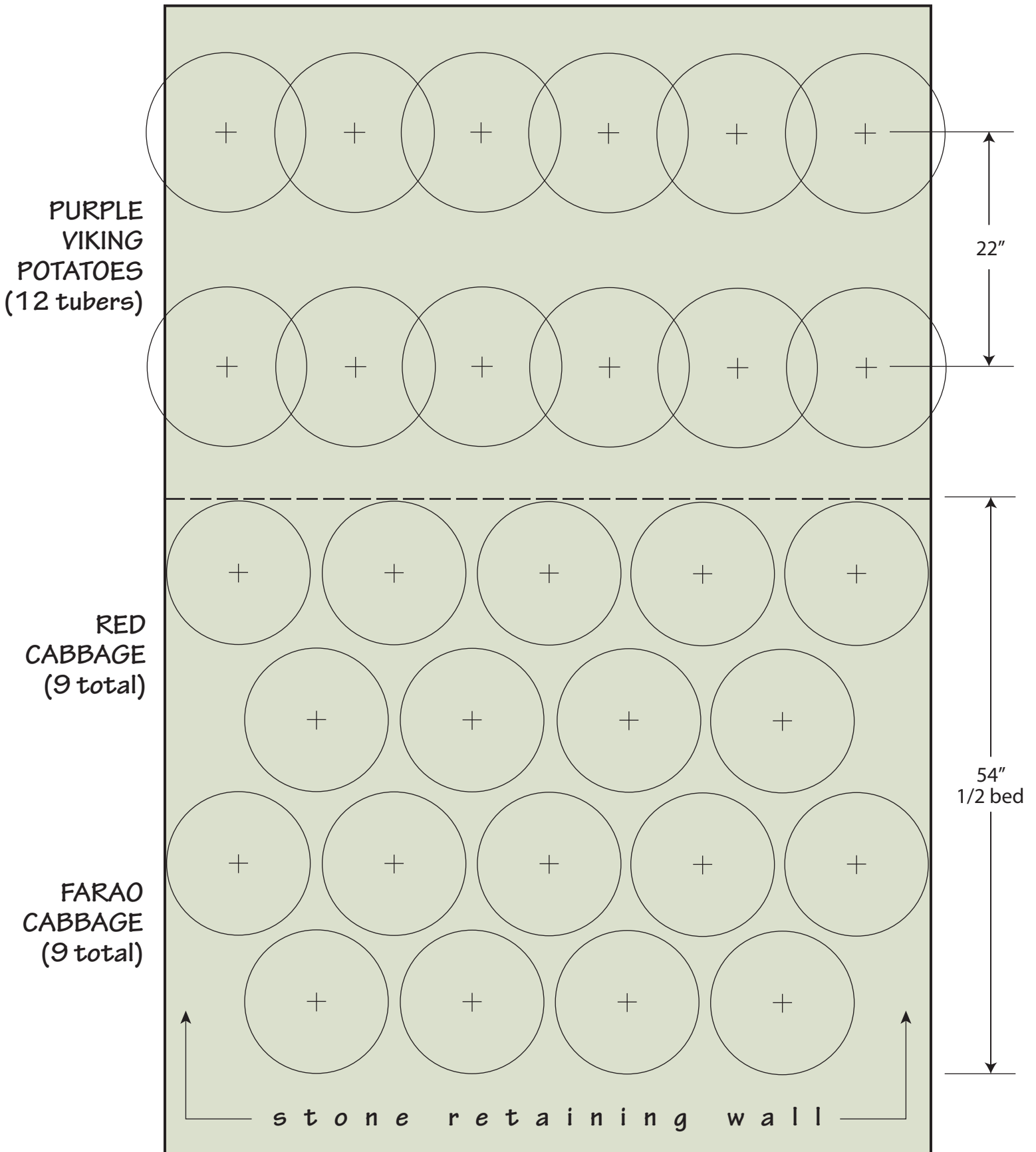

# 2016 CABBAGE, POTATO & FALL BRASSICAS BED (Fall)

SAVOY  
CABBAGE  
(3 total)

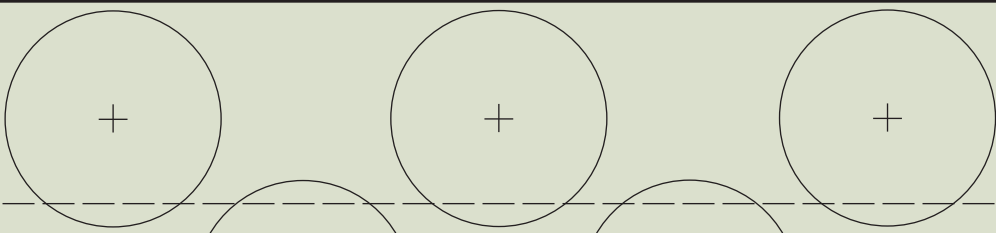

BISHOP  
CAULI-  
FLOWER  
(10 total)

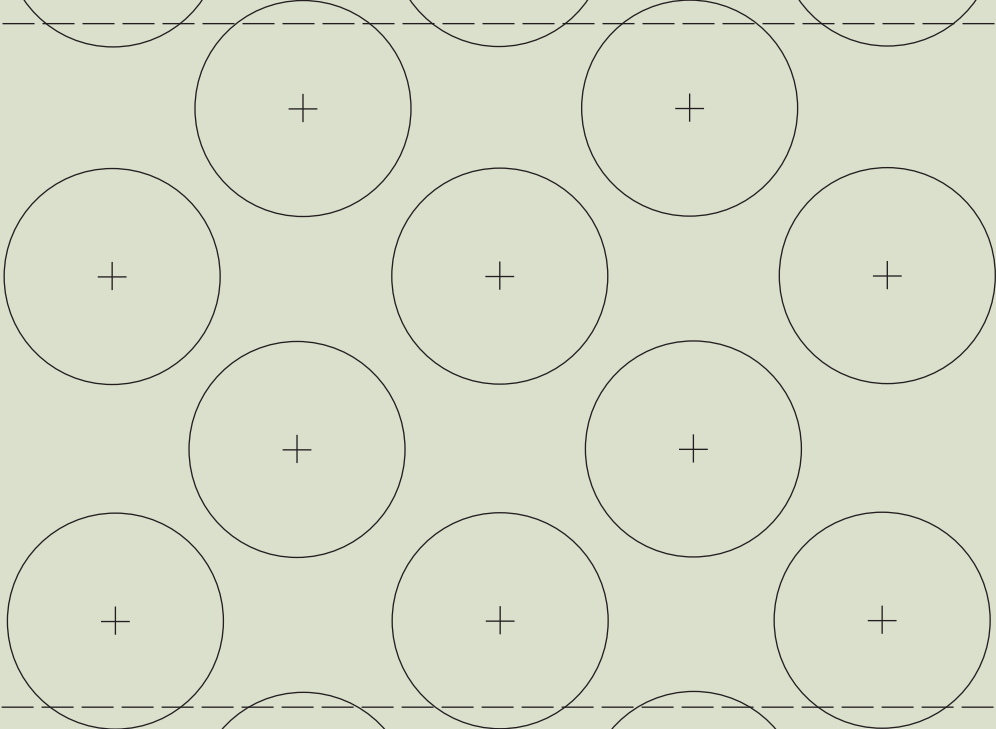

DENALI  
CAULI-  
FLOWER  
(10 total)

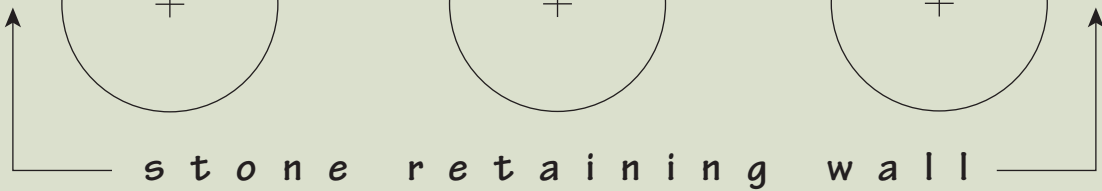
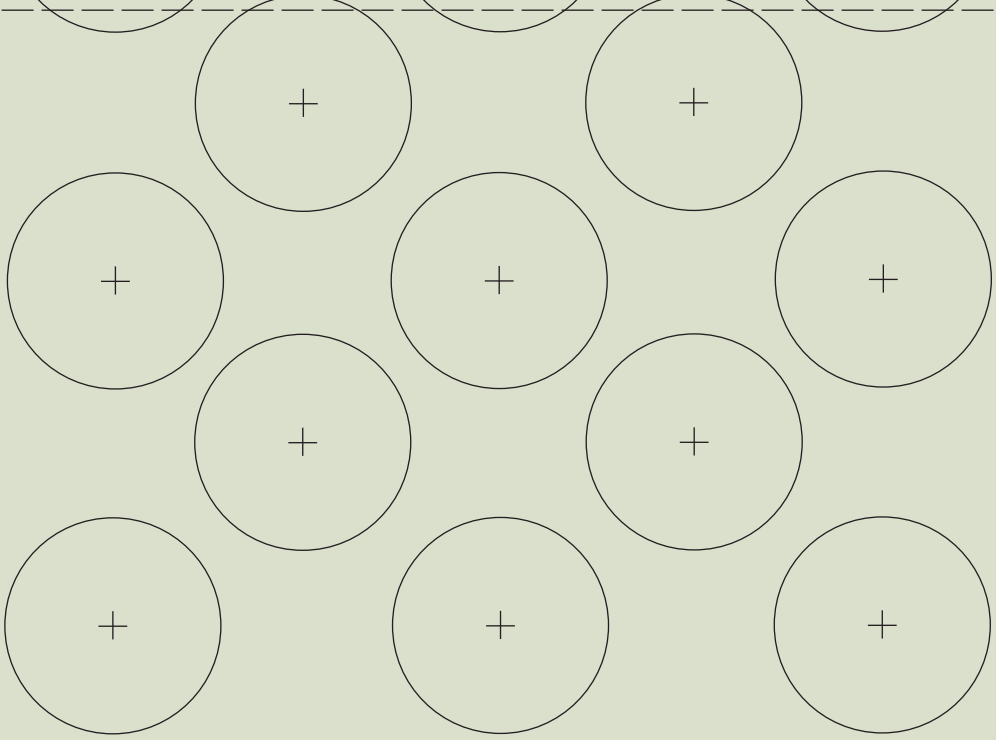

# 2016 CARROT, BEET, CELERY & FENNEL BED

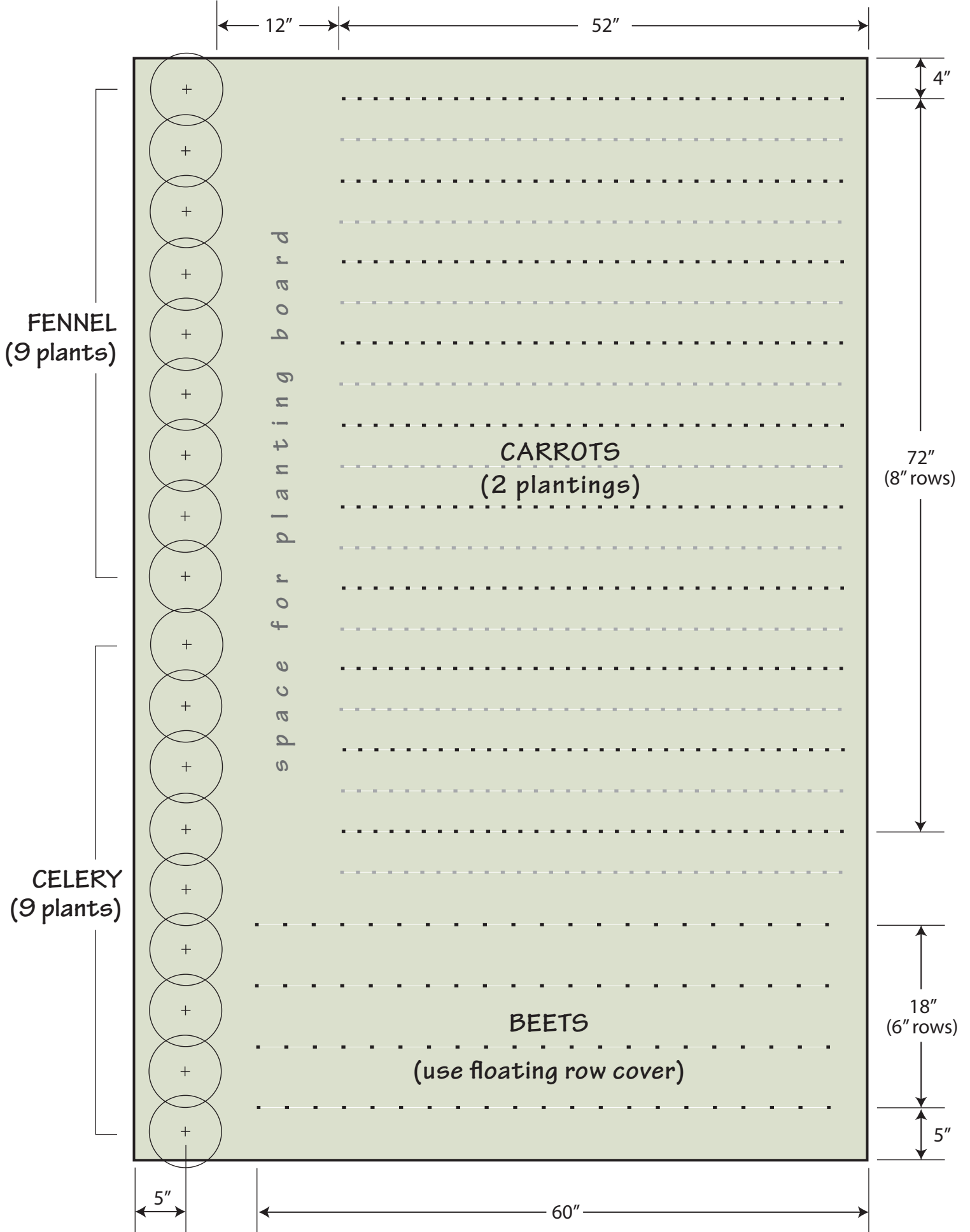

# 2016 WINTER SQUASH BEDS

## Winter Squash (beside philosopher's stone)

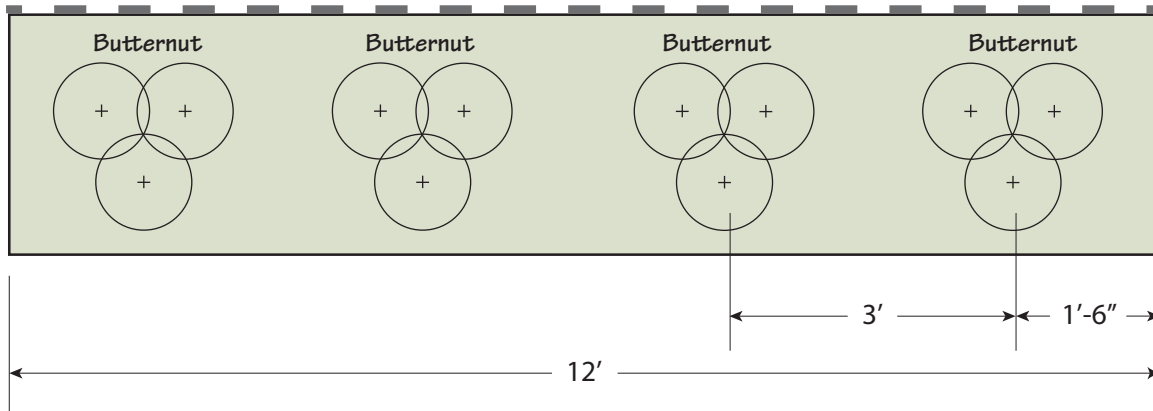

## Winter Squash (beside sunflowers & Jerusalem artichokes)

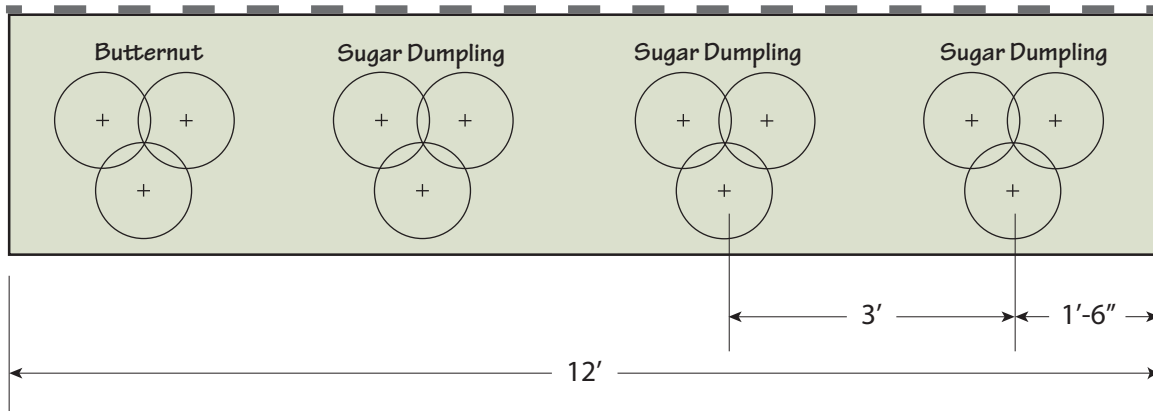

# 2016 PUMPKIN, CUCUMBER & WATERMELON BEDS

## Pumpkins

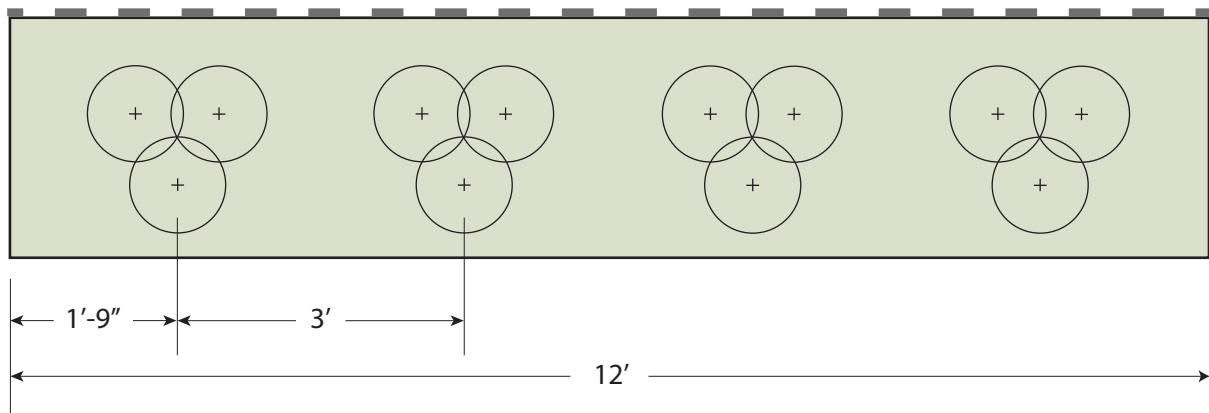

## Cucumbers & Watermelons

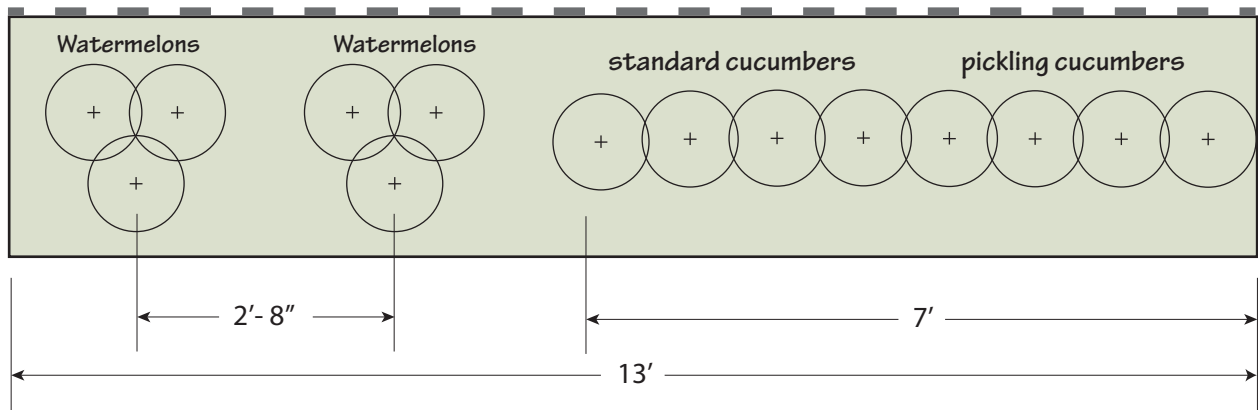

# 2015 KALE, COLLARD, SWISS CHARD & BOK CHOI BED

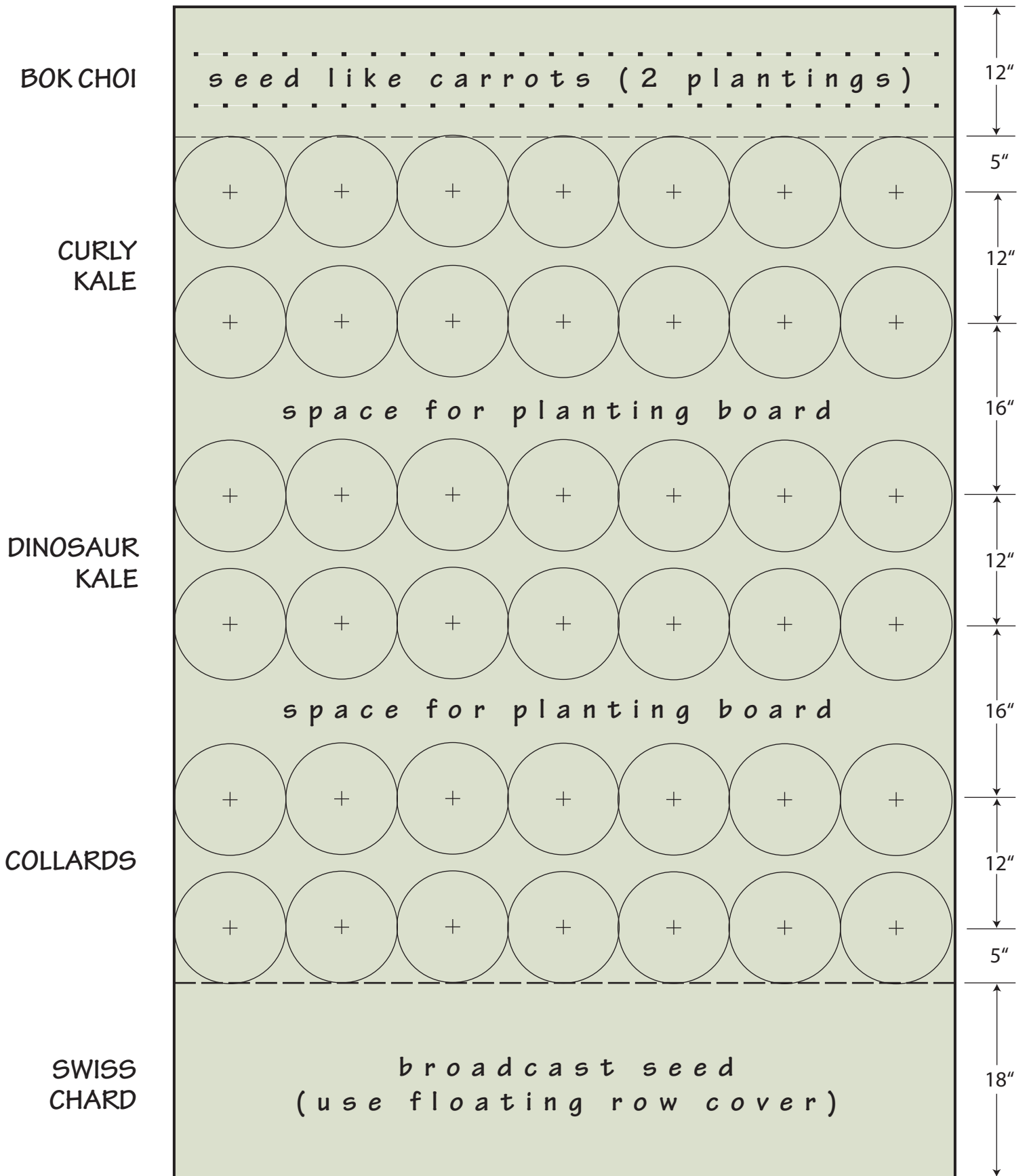



# 2016 LETTUCE BED & SCHEDULE

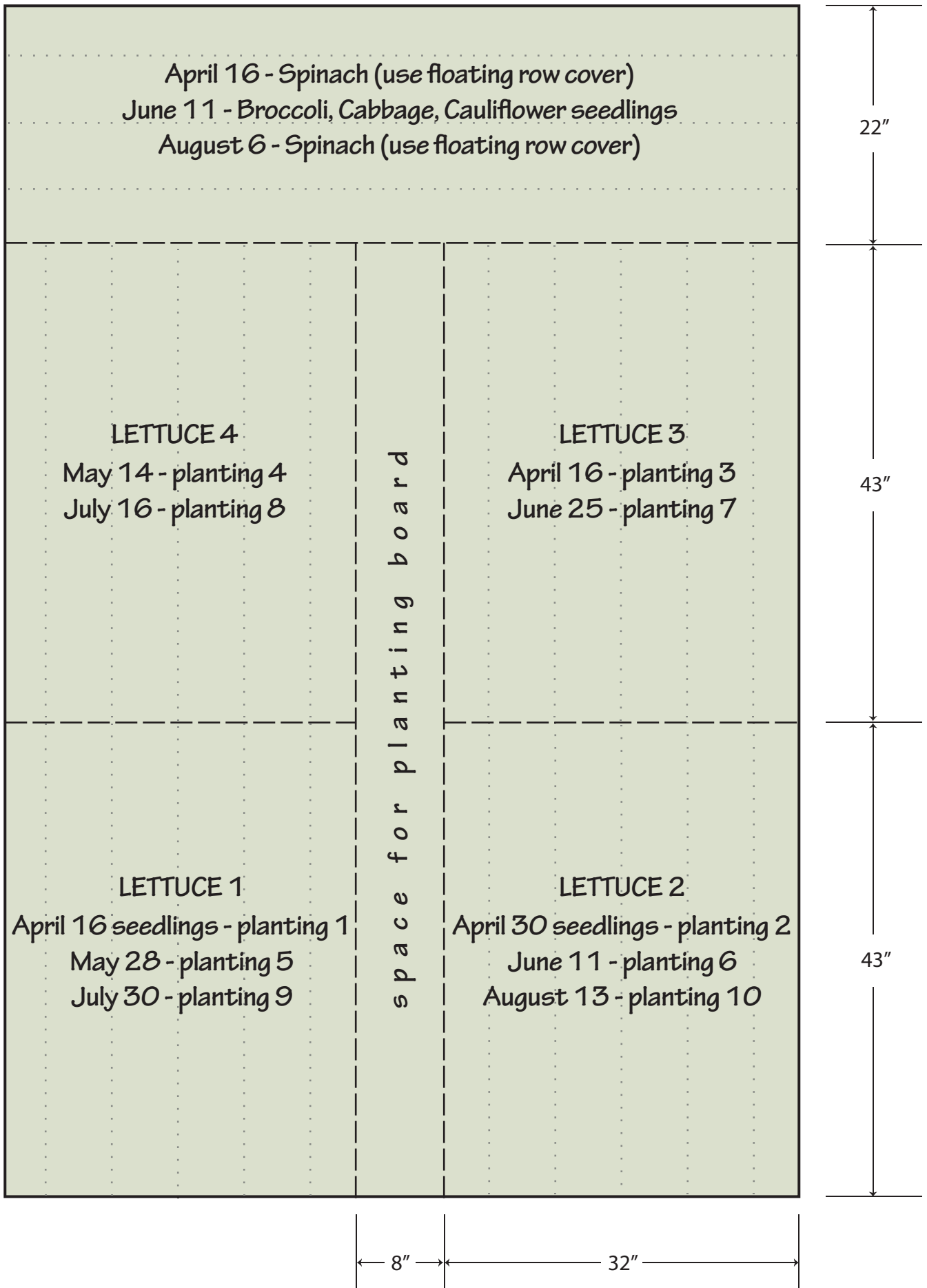

# 2016 OKRA, FAVA BEAN & TOMATILLO BEDS

## OKRA (11 plants)

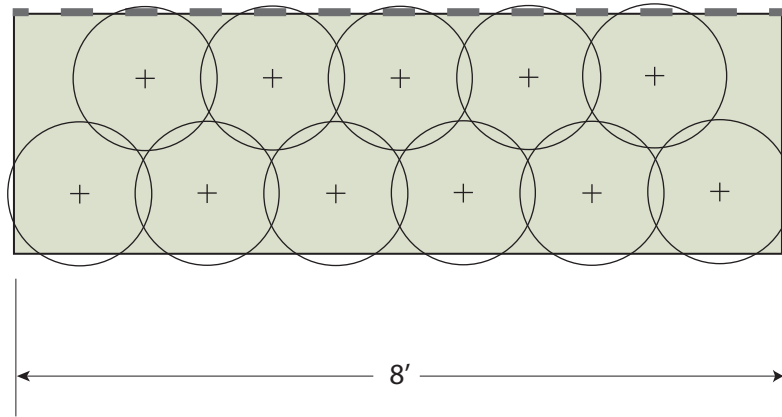

## FAVA BEANS

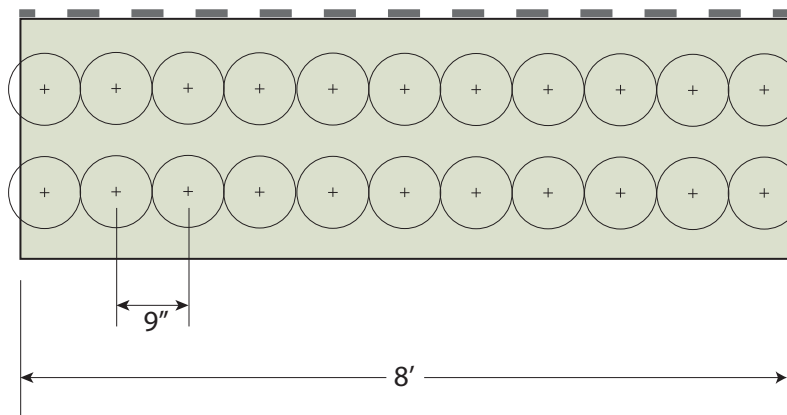

## TOMATILLOS (start with floating row cover)

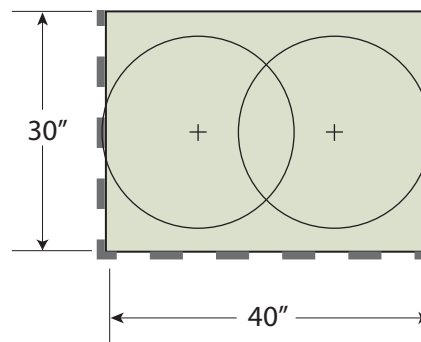

# 2016 ONION, GARLIC, LEEK & SCALLION BED

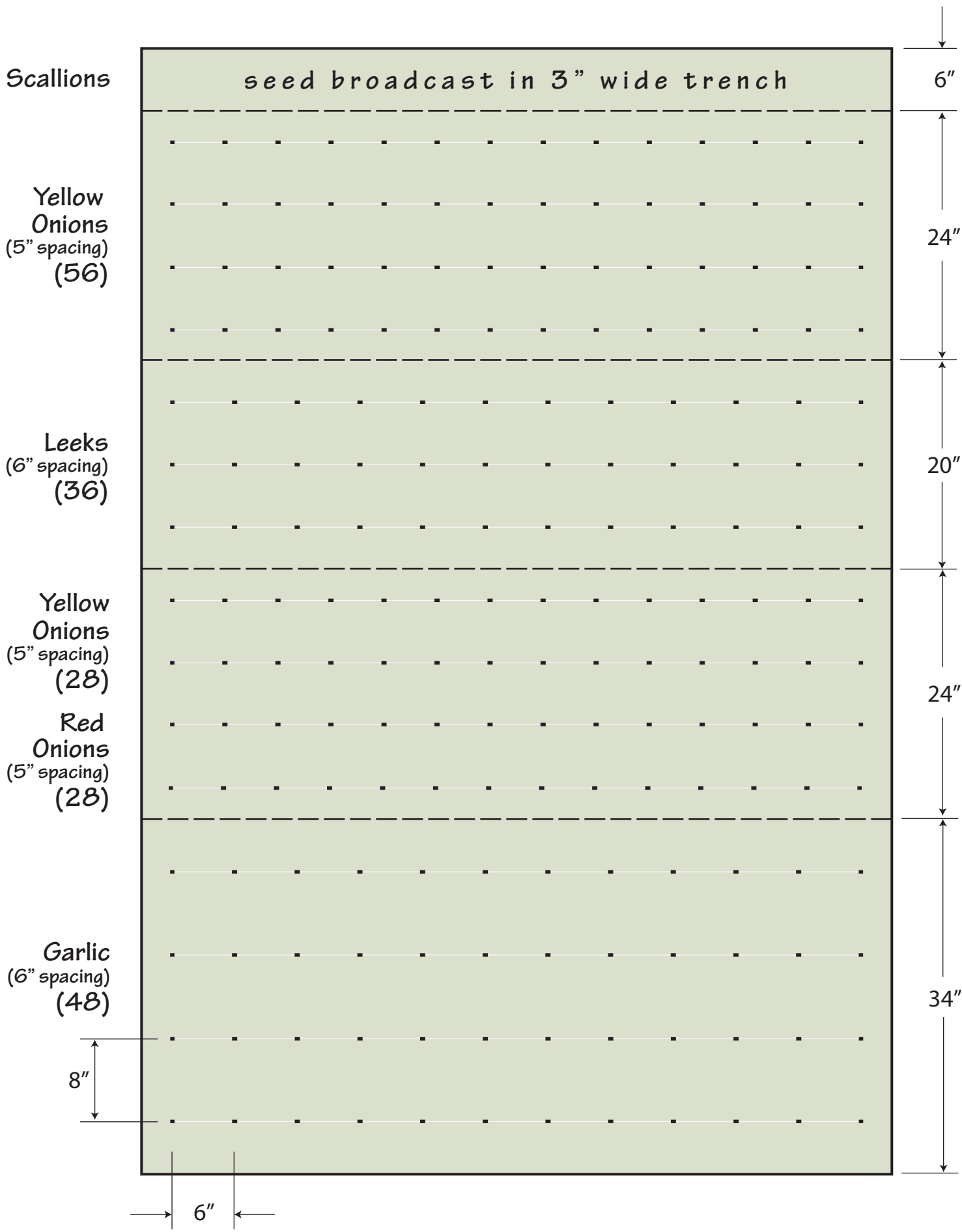

# 2016 PEPPERS & EGGPLANT BEDS

## Peppers (6 Poblano, 4 Italian, 4 Bell, 1 each of 7 others)

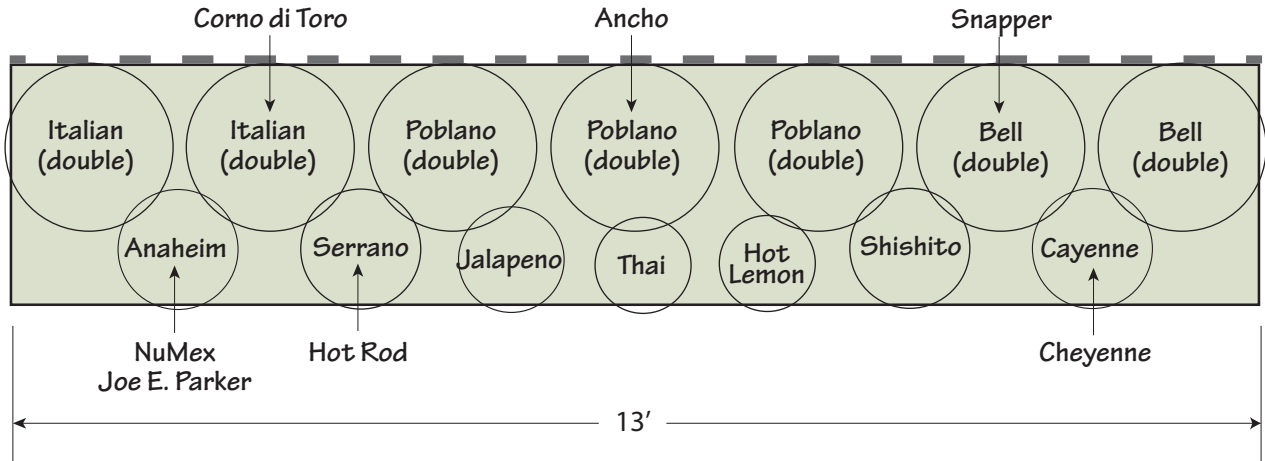

## Eggplant (6 Asian, 6 Italian, 1 white)

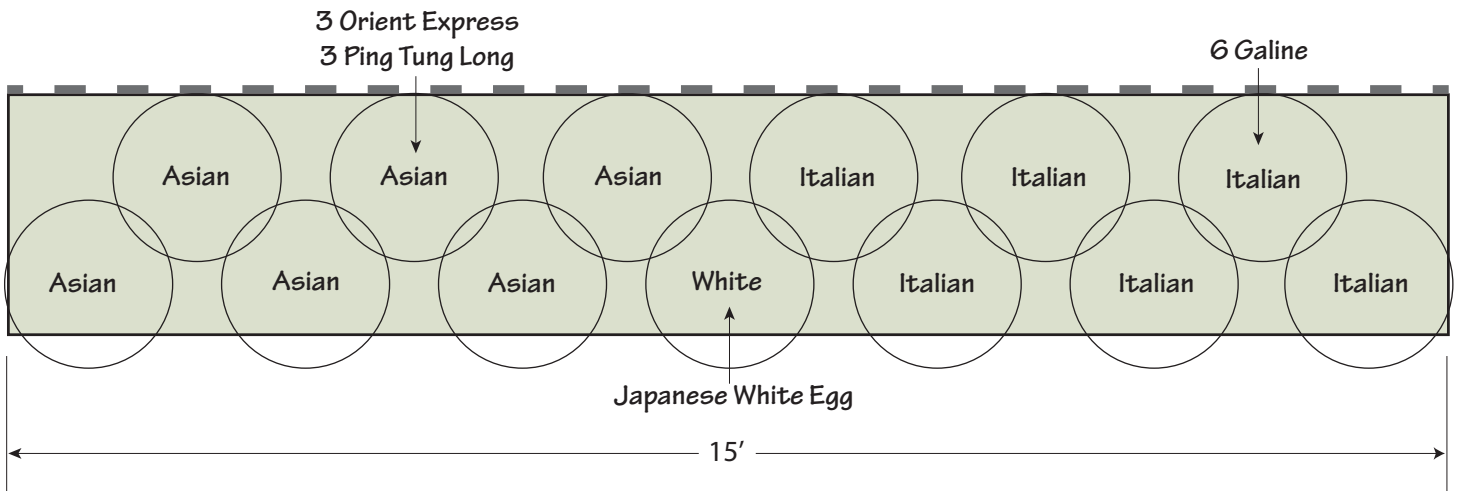

# 2016 POTATO, FALL BROCCOLI & CABBAGE BED (Spring)

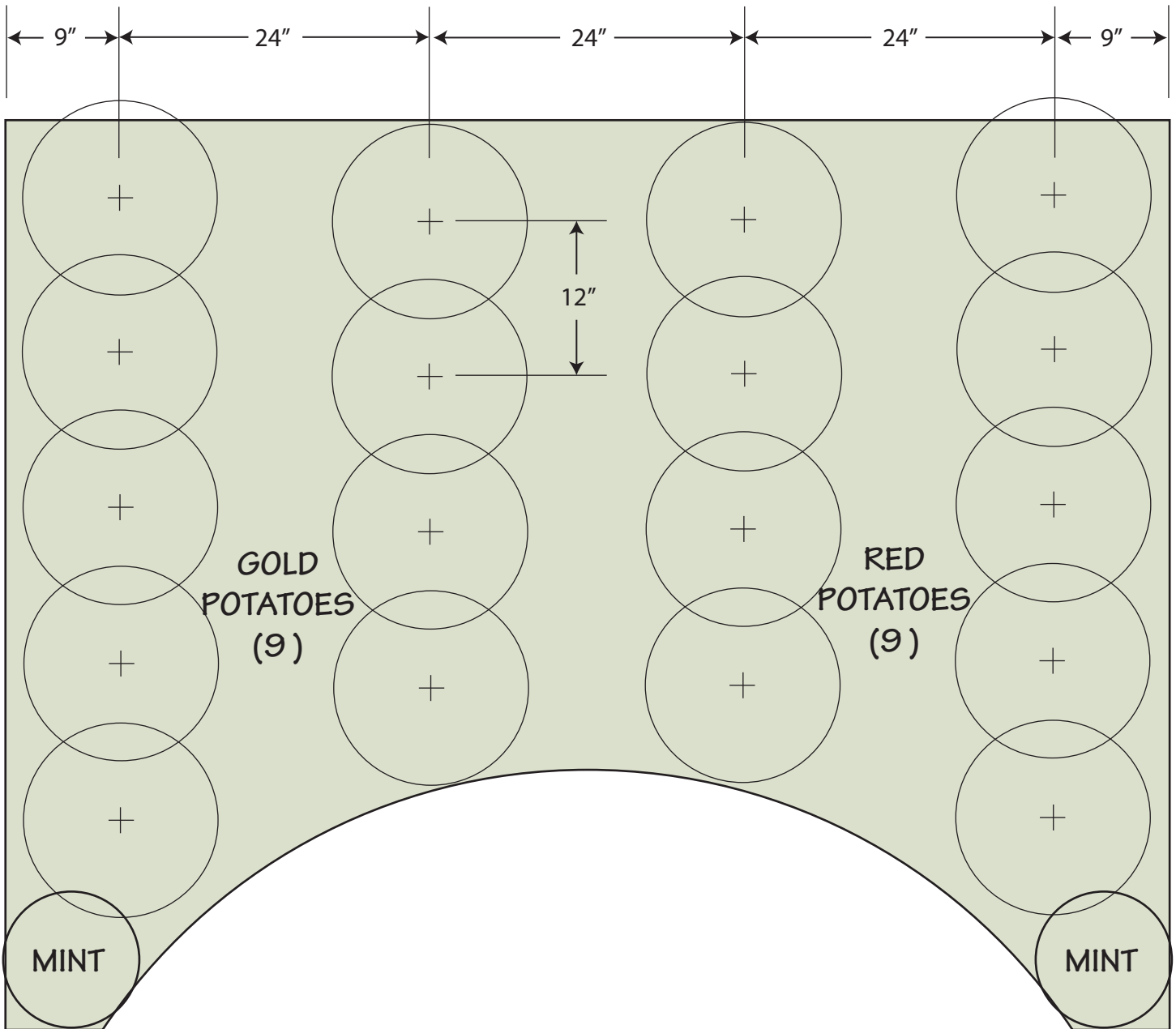

# 2016 POTATO, FALL BROCCOLI & CABBAGE BED (Fall)

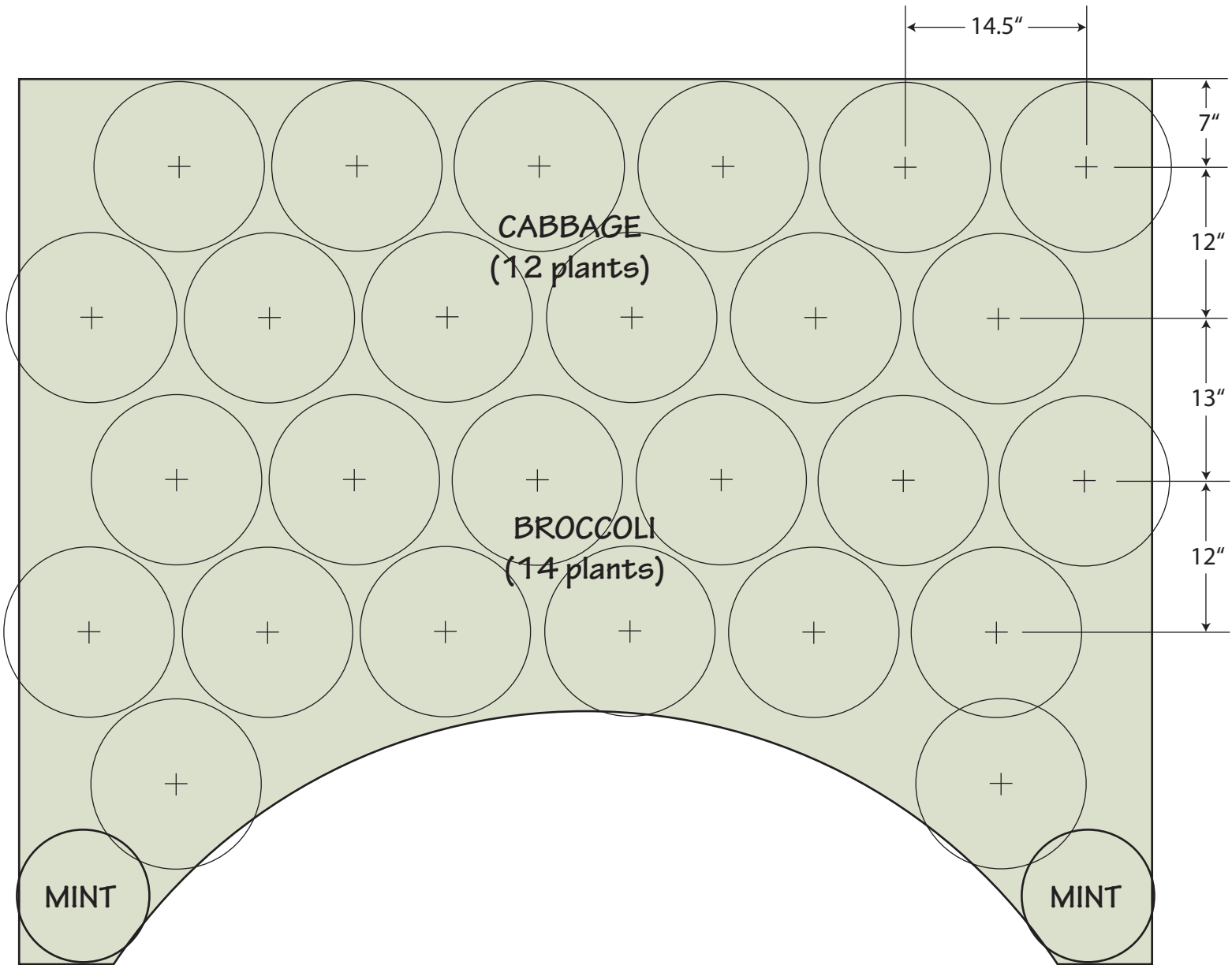

# 2016 SWEET POTATO & PARSNIP BED

PARSNIPS

SWEET  
POTATOES  
(24 slips)

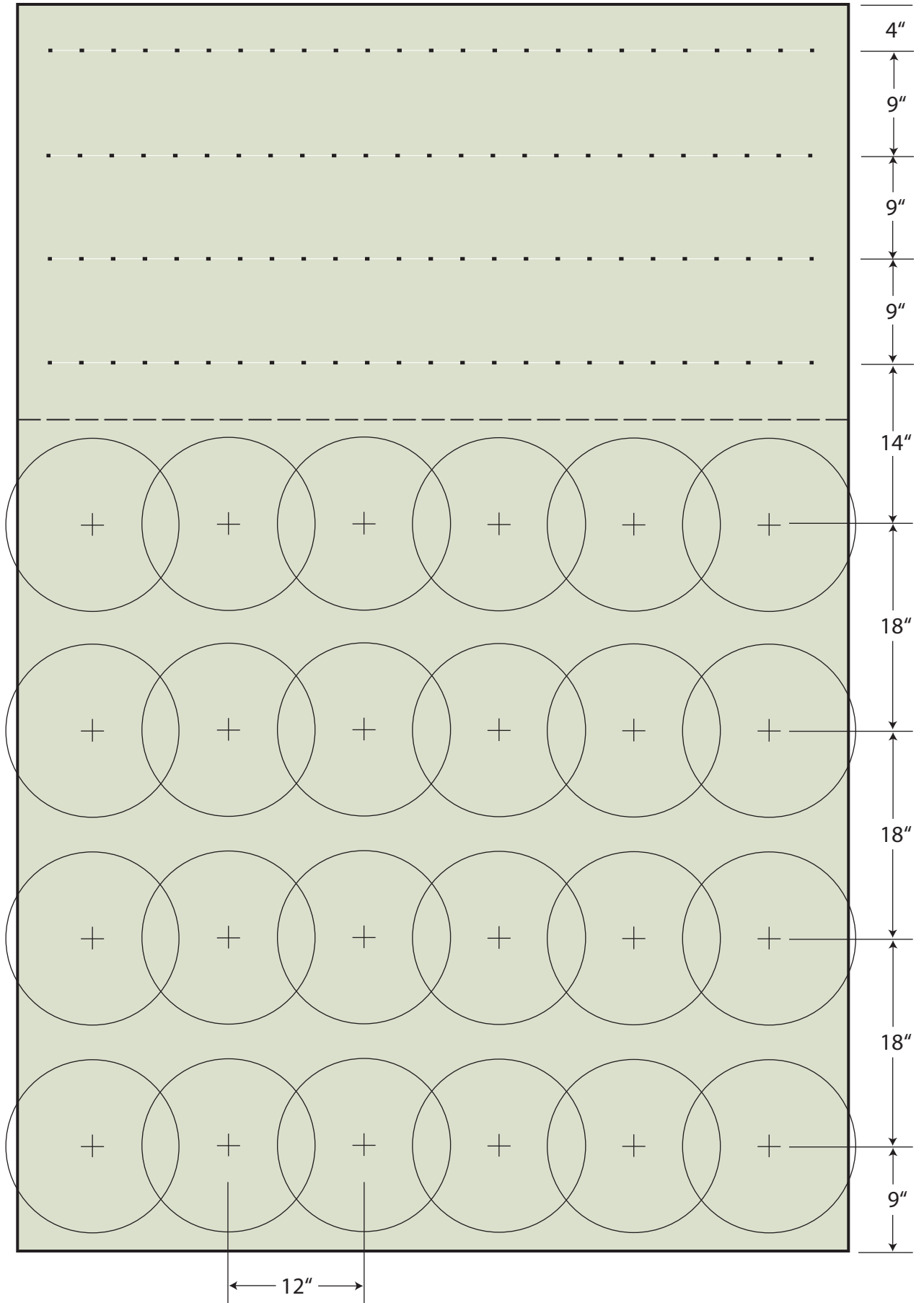

# 2016 THREE SISTERS BED

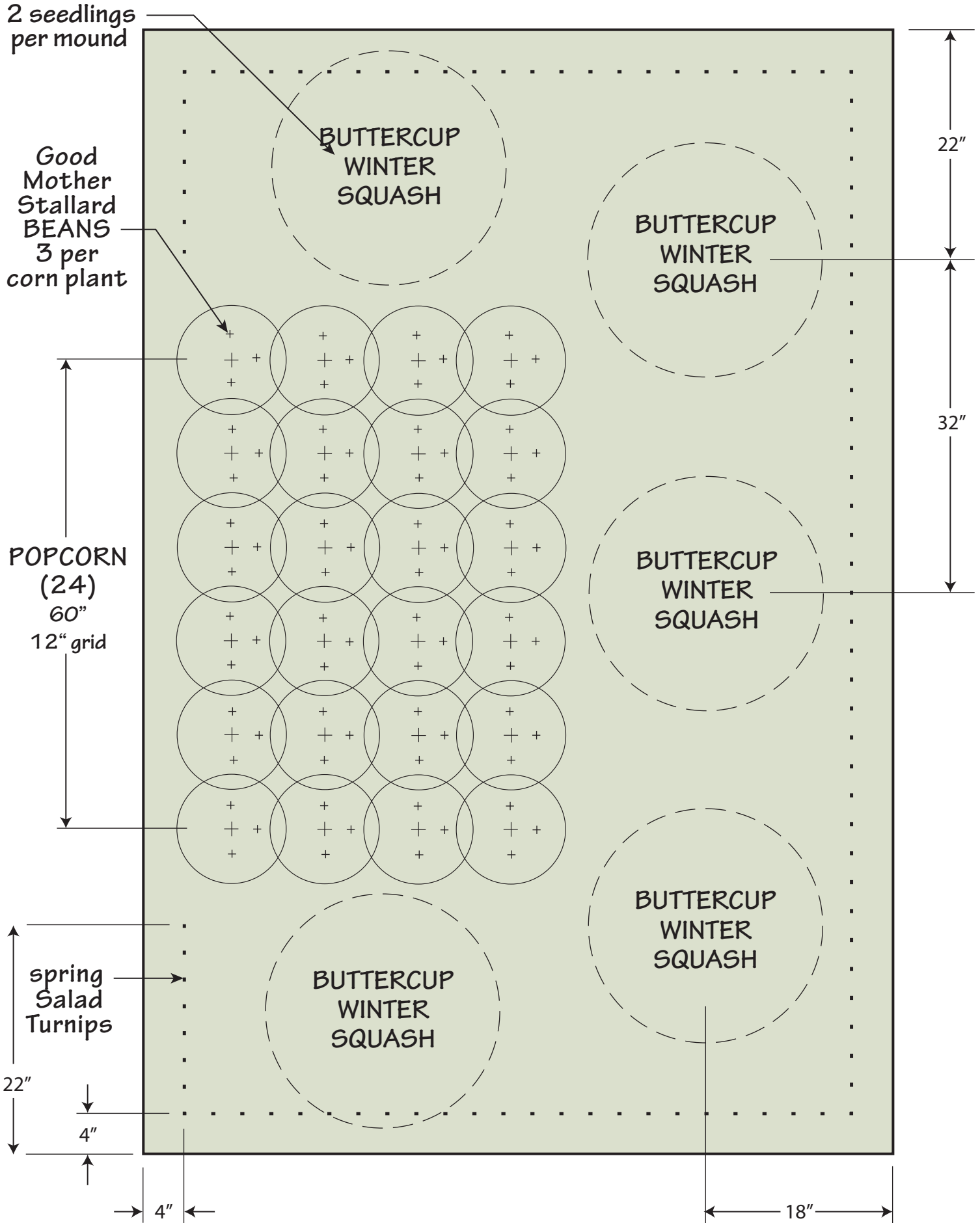



# 2016 TOMATO, BASIL & ONION SET BEDS

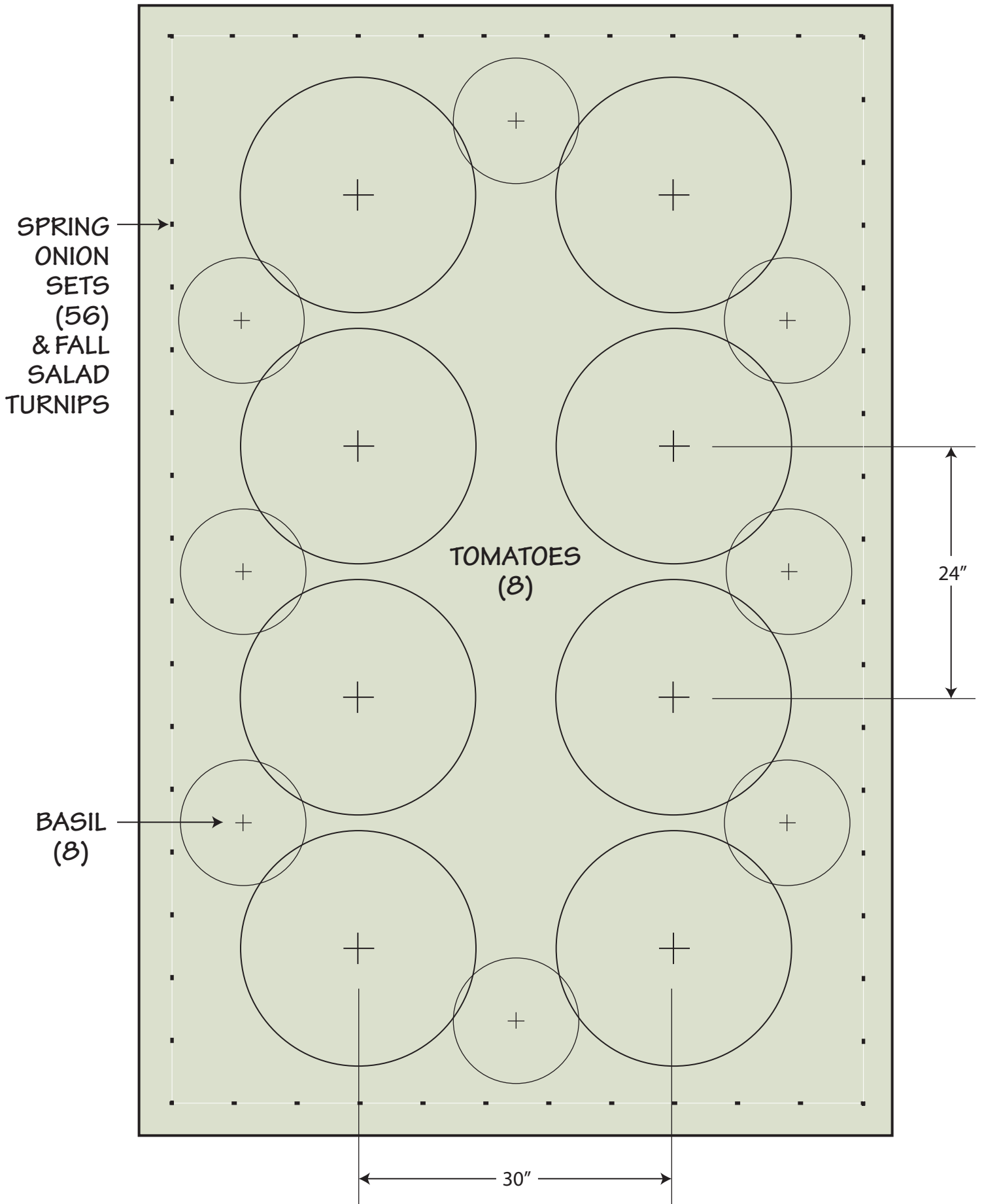

# 2016 ZUCCHINI & SUMMER SQUASH BED

